

USER MANUAL

TC 600GDAN Refrigerator



THERMOTECHNIKA-CROWN COOL KFT.

Headquarters: H-2800 Tatabánya, Csarnok str. 17. | Tax Identification Nr.: 12123067-2-11 | Registration Nr.: 11 09 006790
Showroom and Mailing Address: H-1103 Budapest, Kőér str. 3/F | Phone: +36 1 260 7126 | E-mail: info@tchungary.com

DEAR CUSTOMER!

Welcome as the proud owner of our TC 600GDAN refrigerator. In this booklet, we aim to provide you with some helpful tips to maximize the utility of your device.

If you have any questions or feedback regarding our products, please feel free to reach out to us!



IMPORTANT INFORMATION

For safe and prolonged operation, please carefully read and adhere to the instructions provided in the user manual to ensure that the equipment operates properly and complies with warranty terms.

The manufacturer and distributor are not liable for malfunctions or damages resulting from the omission of instructions outlined in the user manual or from non-standard usage.

Manufacturer:

THERMOTECHNIKA-CROWN COOL Kft.

H-2800 Tatabánya, Csarnok str. 17.

Tel.: +36 1 260 7126

E-mail: info@tchungary.com

Contents

1.	INTRODUCTION.....	3
2.	PACKAGING, SHIPPING	3
3.	STARTUP.....	5
3.1	Optimal Placement and Energy-Saving Operation.....	5
4.	OPERATION	6
4.1	General Information	6
4.2	Temperature Control	8
4.3	Defrosting	9
4.4	Cleaning	9
4.5	Repair	10
5.	TECHNICAL INFORMATIONS	11
5.1	Technical Information of the Product.....	11
5.2	Wiring Diagram.....	12
5.3	Energy Label.....	13
5.4	Exploded View	14
5.4.1	Item List.....	15
6.	DECLARATION OF CONFORMITY.....	16

1. INTRODUCTION

The refrigerator is equipped with 5 pcs shelf(ves), plastic coated exterior and interior, adjustable feet, digital temperature control, digital temperature display, internal light, dynamic cooling. This product is also available in white and anthracite.

2. PACKAGING, SHIPPING



- Ensure the equipment is transported properly, it should only be transported in an upright position! Upon arrival, please inspect the product for any damages.

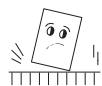

- Do not lean the equipment on the ground when removing the packaging! For equipment with glass doors, pay special attention to the glass surfaces.

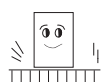

- After removing the packaging, always place the equipment on a solid, dry, and horizontal surface. Make sure to remove any inappropriate items from the machine (e.g., adhesive, film) and ventilate the equipment. Set up the device in a location where the floor has adequate load-bearing capacity.

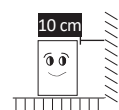

- Maintain a minimum distance of 10 cm between the back and sides of the equipment and the wall.

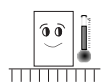

- Insufficient ventilation may deteriorate the cooling performance.

- Under no circumstances tilt the equipment at an angle greater than 45 degrees from the vertical and protect it from significant vibrations and impacts (during transportation, lifting, and placement), as these may cause operational issues.

- If the equipment has been stored/transported in cold conditions, wait at least 12 hours before starting it up.

- When storing, place the equipment in a dry, moisture-free location in a single row.

- Ignoring security markings may result in product damage.



SAFETY REGULATIONS

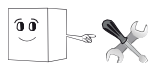

- Assembly and electrical connection of disassembled machines should only be performed by a professional.

- Please note that the device operates intermittently, so the compressor stopping does not indicate it is free of voltage. Therefore, it is **STRICTLY PROHIBITED** to touch the electrical parts of the device before unplugging the connector!



- Devices can only be connected to a 230V nominal voltage, alternating current network. The socket should be equipped with a 10-16 A fuse with protective grounding or a circuit breaker ("automatic") to protect against short circuits and overloads. If the socket does not meet these requirements, consult a professional to have it modified accordingly. Do not extend the power cord of the device!

- Assembly and disassembly of the equipment should be entrusted to a professional.
- The equipment should not be operated with a coiled power cable!
- Ensure that the electrical components of the power supply are adequate; connect the machine only to a grounded electrical outlet.
- Before electrical connection, ensure that the voltage specifications of the network match those of the device.
- Use only the assembled power plug, never use a T-type adapter, as it may overheat. The socket should be easily accessible.
- Avoid using electrical extension cords whenever possible. Use a grounded extension cord if necessary.
- Always unplug the power cord by pulling the plug, otherwise, it may lead to wire breakage, resulting in electric shock!
- Do not store flammable or volatile materials in the device or near it.
- If unplugging the connector from the outlet, wait at least 5 minutes before plugging it back in.
- Please do not touch the electrical components with wet hands! A fault in the electrical wiring can cause a short circuit or fire.
- If the device is used in a damp room, install an electrical interrupter.
- Use the device only indoors. If the device is exposed to moisture or rain, it may cause a short circuit.
- Never pour water directly onto the device as it may cause a short circuit.
- Cooling performance decreases if the device is placed where the refrigerator is exposed to heat (e.g., near a stove, in direct sunlight).
- Cooling performance decreases if the device is placed where ventilation is inadequate.
- Do not place heavy or water-containing objects on top of the device. Falling objects may cause injury. Drainage water can damage the electrical insulation, leading to a short circuit.
- Make sure the device does not tip over when moved.
- A tipping machine can cause serious injury.
- Ensure that the equipment is inaccessible to children.
- Do not drill holes in the equipment or attach anything to it.
- Never insert pointed objects or fingers into the refrigeration unit, as the high-speed rotation of the fan can cause injury.
- Do not lean on the door, as it may cause the device to tip over.
- Avoid strong impacts with your hands or other tools on the display case, as it may result in glass breakage, posing a risk of injury.
- Adjusting the door to be level can only be done by a service technician, as it requires disassembly of the structural elements.
- Open and close the refrigerator door by its handle.
- Do not leave the refrigerator door open for extended periods.
- Store items in the refrigerator in a way that does not obstruct airflow.

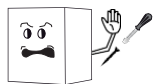
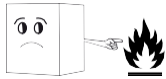

3. STARTUP

3.1 Optimal Placement and Energy-Saving Operation



INSTALLATION

- Always ensure the refrigerator is placed horizontally using the adjustable legs to facilitate noiseless operation and proper drainage of defrost water.
- Maintain the appropriate distance between the refrigerator and the wall! Avoid placing the appliance in the airflow of an air conditioner. Do not obstruct the device with objects that hinder proper ventilation.
- The refrigerator operates most efficiently when exposed to minimal external heat! Cooling efficiency decreases, and energy consumption increases if exposed to direct sunlight or placed near heat sources (e.g., stove, radiator).
- Optimal operation of the device is between temperatures of +18°C to +30°C; operating it in temperatures outside this range, or outdoors, adversely affects the guaranteed technical specifications.
- The appliance operates optimally in environments with temperatures up to 25°C and humidity levels of up to 60%. Adjust the internal temperature as needed, as overcooling consumes extra energy.
- Only load the refrigerator with goods after the internal temperature has cooled down.
- To save energy and prevent frosting, avoid placing items warmer than room temperature in the display case.
- Ensure that shelves are securely placed. Do not overload them.
- Each shelf can bear a load of up to 30 kg. When inserting shelves, ensure proper alignment to prevent accidents and injuries.
- Do not overreach items on shelves. Avoid placing goods directly on the bottom of the device; use shelves instead.
- If the refrigerator has been stored in a place colder than +10°C, let it acclimate to room temperature before connecting it to the power supply.
- Place the refrigerator in a well-ventilated, dust-free area, ensuring the ventilation grilles at the bottom of the unit are unobstructed. Better air circulation in the compressor compartment leads to improved and more economical cooling.
- Before starting the appliance, familiarize yourself with the temperature control instructions for your own benefit.
- When opening the door of the device, the internal fan of the machine stops, so that warm air does not enter the interior of the device!

4. OPERATION

4.1 General Information



MAINTENANCE

- During maintenance or repairs, please disconnect the equipment from the power supply!
- Repairs should only be conducted by a professional. Contact authorized service for any repair work! Failure to follow the instructions outlined in the user manual may result in the loss of warranty coverage due to malfunctions caused by such negligence.
- In case of any malfunction, always turn off the device until the technician arrives. It is the responsibility of the customer to provide alternative refrigeration for the safe storage of goods during the repair period.
- Please be aware that the device operates intermittently, so the compressor stopping does not indicate it is free of voltage. Therefore, it is **STRICTLY PROHIBITED** to touch the electrical parts of the device before unplugging the connector!
- For door lock or LED strip replacement, contact the professional service.
- We recommend performing maintenance on the equipment 4-6 times a year! Have cleaning processes carried out by a professional service.

The manufacturer and distributor are not liable for malfunctions resulting from the following situations:

- Improper installation (not in accordance with the user manual).
- Use not in accordance with the user manual.
- Malfunction due to incorrect maintenance
- External electrical disturbances
- Malfunction due to the use of non-original parts
- Malfunction resulting from damage and glass breakage.



BEFORE YOU CALL FOR SERVICE

Before calling for service, please ensure the following:

If the refrigerator doesn't start:

- Check if it's properly connected to the electrical outlet.
- Verify if the fuse hasn't blown or the circuit breaker hasn't tripped.
- Ensure the temperature control isn't set to "0" in the case of a mechanical thermostat.

If the compressor runs continuously:

- Ensure that airflow isn't obstructed by products.

If the refrigerator is noisy:

- Check if it's in contact with the wall or any other furniture.
- Verify if it's leveled horizontally.

If the products are not at the right temperature:

- Verify the set temperature.
- Check if the ambient temperature isn't too high and adjust the thermostat accordingly. Keep in mind that it may take longer to reach the desired temperature when loading warm products.

If there is condensation water at the bottom of the appliance:

- Make sure the appliance is placed horizontally.

If the evaporator freezes (only applicable to a block evaporator):

- Don't panic, the digital temperature control will automatically defrost it. In this case, the compressor start is delayed. The compressor restarts after the defrosting cycle. Contact service only if icing persists.

If smoke leaks from the cabinet:

- Immediately disconnect the plug and contact service.

SERVICE CONTACTS

Mobile: +36-30/685-3694

+36-30/350-7268

E-mail: dizpecser@tchungary.com

Address: H-1103 Budapest, Kőér str. 3/f.

4.2 Temperature Control

The device starts working after plugging in the power plug and turning on the main switch (if present).

4.2.1 General User Manual

The operating temperature of the appliance is regulated by the factory-set electronic thermostat. The built-in temperature controller automatically regulates the internal temperature of the display case/refrigerator within the factory-set temperature limits by switching the refrigerator compressor on and off.

Attention!

The sensor responsible for temperature is located in the appliance's shelf rail, at the bottom, obstructing it may result in unwanted operation of the appliance. To avoid malfunction, when placing products, keep a distance of at least 3 cm from the sensor.

Its position is indicated by the following pictogram: (only for refrigerators)



The buttons on the thermostat allow access to various hidden menus. However, adjusting these hidden menu parameters is the responsibility of a professional. Please note that altering the thermostat's parameters in this way may void the appliance's warranty!

Using a continuously low temperature (near 2°C) results in continuous, uninterrupted operation of the appliance and may cause frosting on the display surface and glass. The mentioned frosting can be caused by environmental temperatures higher than 25°C or humidity levels exceeding 60%.

LTC-90 Thermostat Operation

The control of the appliance is performed by the following digital temperature controller.







Explanation of the temperature controller operation and button handling:

The appliance is equipped with a main switch. By pressing the  button briefly, the refrigerator can be turned on or off.

It is possible to adjust the temperature of the appliance between +2°C and +13°C. The recommended temperature is 6°C.

If adjustment is necessary, it can be done as follows:

Press and hold the  button for 4 seconds until "ST" appears on the display. By briefly pressing the , the value can be adjusted with the UP  and DOWN  arrows.

Once the temperature is set, press the RST/*  button to save the value.

Manual defrosting or switching off the appliance is not required, as the appliance fully automates the defrosting process at regular intervals!

Pressing the icon for the lighting switch  allows you to turn the light on or off.

4.3 Defrosting

Operating the appliance leads to the condensation of some moisture content from the refrigerated space in the form of frost or ice buildup on the refrigeration components, which impairs the cooling performance of the appliance. In the case of a digital thermostat, defrosting is automatic, but environmental conditions deviating from factory specifications (such as high ambient temperature or humidity in the store), as well as overloading or potential icing of the appliance, may require manual defrosting, which should be done as follows:

- Remove items from the display case and protect them from heat.
- Press and hold the  button (depending on the model, this button may also be labeled "def" or ▼*C) for approximately 3 seconds to initiate defrosting. The display will illuminate and show "dF," indicating that defrosting is in progress. Upon completion of defrosting, the appliance will automatically restart.

To fasten the defrosting process, do not use sharp or pointed objects or electrical appliances.

4.4 Cleaning

GENERAL CLEANING

- Always disconnect the device from the power supply before cleaning!
- Before first use, clean the device and wipe it dry.
- Do not use flammable sprays for cleaning. Do not pour washing water onto the appliance, as it can cause a short circuit and be life-threatening.
- External and internal surfaces of the refrigerator can be cleaned with a soft cloth or sponge and tap water, or with household dishwashing detergent.
- During cleaning, ensure that the door seal does not come into contact with oil or grease, as it may become porous.
- Do not clean the glass door with abrasive cleaners or scratching materials!

- The condenser should be cleaned 4-6 times a year, while the appliance is switched off, using a vacuum cleaner or a stiff brush. Proper maintenance of the condenser is essential, as improperly maintained condensers can cause loss of performance and even compressor burnout. Damages resulting from this are not covered by warranty.
- Always open or close the appliance using the factory-installed handle to avoid damaging the door seal.
- Different types of stainless steel sheets (201/202/430/304) react differently to various cleaning agents. Appliances made of 201 and 430 stainless steel sheets should not be cleaned with acidic or alkaline agents, as these substances can cause staining.
- For information on which type of stainless steel sheet the appliance is made of, please inquire with the dealership!



WASTE MANAGEMENT

After removing the device from use, it must be transported to waste disposal sites for professional disassembly.

4.5 Repair

Repairs to the machine may only be carried out by the manufacturing company or a representative of the service commissioned by it. Any intervention by others may result in the loss of the warranty.

5. TECHNICAL INFORMATIONS

5.1 Technical Information of the Product

DIMENSIONS

External size (mm)	700x825x1880 (H)
Internal size (mm)	600x715x1400 (H)
Net volume (l)	573
Gross volume (l)	602
Net weight (kg)	120
Gross weight (kg)	127
Number of shelves	5
Shelf size (mm)	575x640
Shelf payload (kg)	30

TECHNICAL SPECIFICATIONS

Climate type	N
Temperature range (°C)	+2...+12
Thermostat	Digital
Refrigerant	R290a
Rated voltage (V)	230
Current (A)	1,32
Input power (W)	201
Energy consumption (W/24h)	1,2
Internal material/color	plastic-coated sheet steel / grey
External material/color	steel / white or anthracite
Type of lighting	double vertical LED
Type of cooling	Dynamic

CAPACITY

330 ml glass bottle	450
500 ml glass bottle	320
330 ml can	648
500 ml can	432

ACCESSORIES

Lock	optional
Canopy	optional

5.2 Wiring Diagram

TC 600 GD

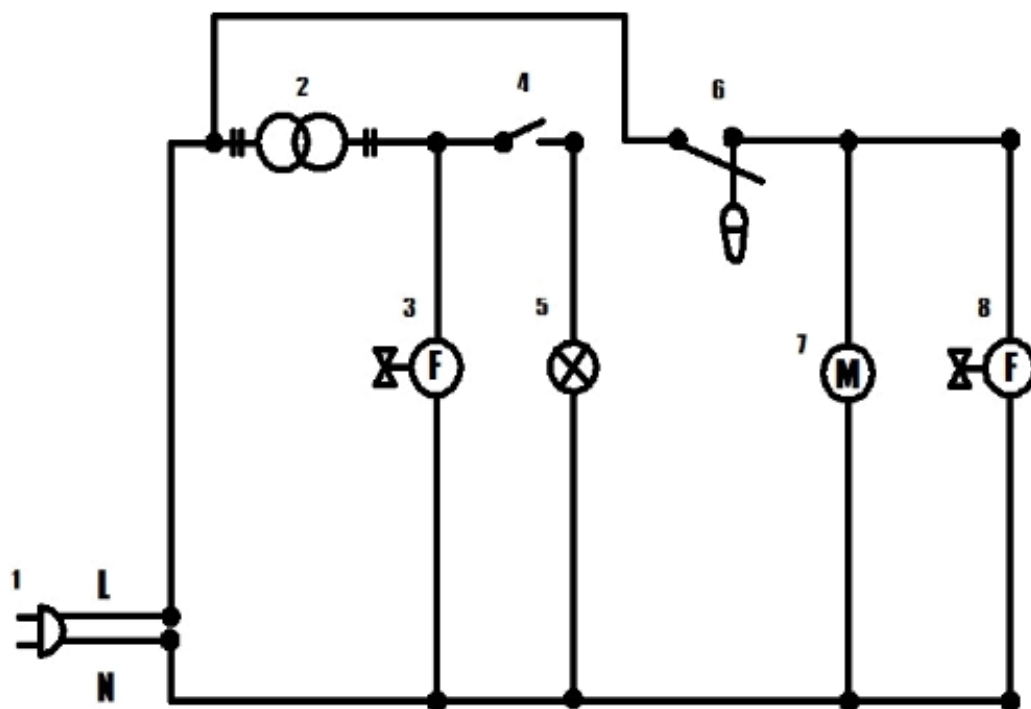

1. Power Cable
2. Transformer
12 VDC
3. Evaporator
Fan
4. Light switch
5. LED Strip
6. Thermostat
7. Compressor
8. Condenser
Fan

5.3 Energy Label

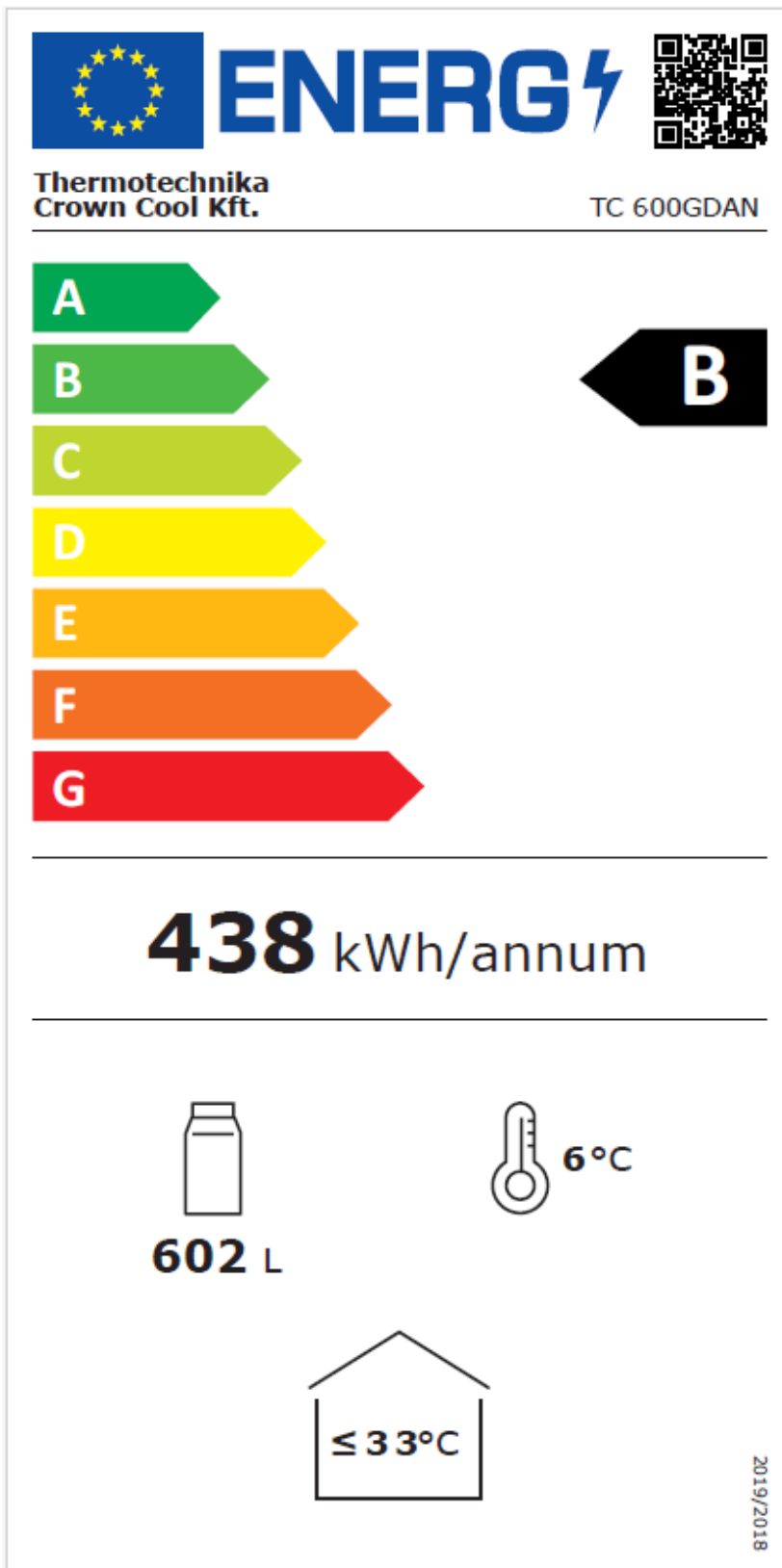

5.4 Exploded View

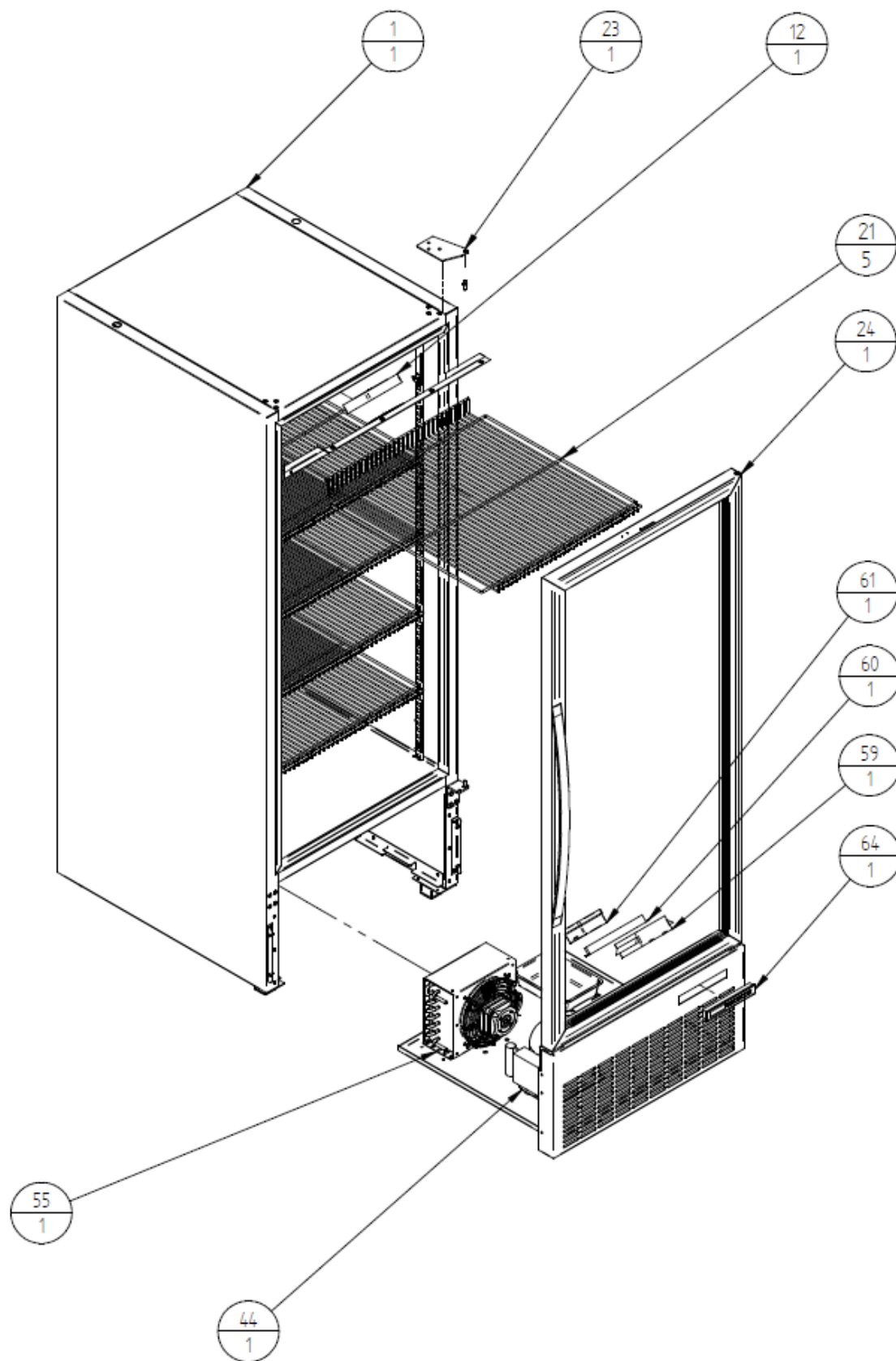

5.4.1 Item List

Szám / Number	Név / Number	Darabszám / Quantity
1	Palást / Body	1
12	Keretventilátor / Fan	1
21	Huzalpolc / Wire shelf	5
23	Zsanér / Hinge	1
24	Üvegajtó / Glass door	1
44	Kompresszor / Compressor	1
55	Kondenzátor / Condenser	1
59	Hőfokszabályzó doboz / Thermostat box	1
60	Tápegység / Transformer	1
61	Kötődoboz / Binding box	1
64	Hőfokszabályzó / Thermostat	1

6. DECLARATION OF CONFORMITY

A termék megnevezése:	Hűtővitrin
Name of product:	Cooler
Típus:/ Type:	TC 600GDAN
Főbb műszaki adatai: / Main technical data:	230 V, 50Hz, 201 W, 1,32 A, 573 l, 120 kg, R290a
A gyártó neve és telephelye: /	THERMOTECHNIKA - CROWN COOL Kft.
Manufacturer (name and address):	H-2800 Tatabánya, Csarnok u. 17.

Ezt a megfelelőségi nyilatkozatot a gyártó kizárólagos felelősségére adja ki.
This Declaration of Conformity is issued by the manufacturer's sole responsibility.

Kijelentjük, hogy az általunk gyártott fentnevezett termék
Hereby we declare that above mentioned product is

MEGFELEL IN COMPLIANCE

a következő vonatkozó közösségi harmonizációs jogszabályoknak
with the following EU harmonization laws

2014/35/EU direktíva
2014/30/EU direktíva
2011/65/EU direktíva

23/2016.(VII.7.) NGM rendelet
8/2016.(XII.6.) NMHH rendelet
374/2012.(XII.18.) Korm. rendelet

és az alábbi alkalmazott harmonizált szabványoknak
and the following harmonized legislation

MSZ EN 60335-1:1998
MSZ EN 60335-1:2013
MSZ EN 60335-2-89:2010/A1:2016

MSZ EN 55014-1:2017
MSZ EN 50581:2013
MSZ EN 60335-2-89:2010/A2:2018

A nyilatkozatot a Thermotechnika – Crown Cool Kft. nevében tette és írta alá
This Declaration was made and signed on behalf of the Thermotechnika-Crown Cool Kft.

Tatabánya, 2024. 02. 29.

THERMOTECHNIKA-CROWN COOL KFT.
2800 Tatabánya, Csarnok u. 17.
Adószám: 12123067-2-11
-20-



PH

Kiss János
ügyvezető igazgató
Managing Director